

Slide Switch

YSS-2402S SMD TYPE

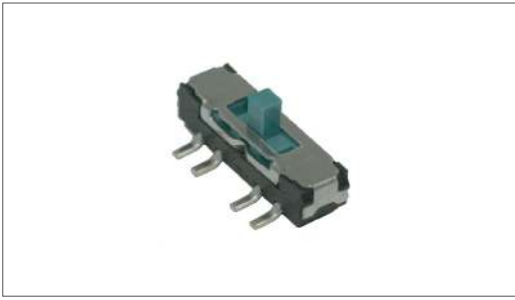

Feature

2mm-travel, 1.5x1.5x2mm stem.
Reflow solderable type of YSS-2402.

Applications

Mode changing for LCD TV, DVD player, mini component, remote controls..etc.

Switches for other machines that requires mode changing activity.

Specifications

Item	Rating	Travel	Contact Resistance	Circuit	Timing	Operating Force	Operating Life
Value	DC 6V 0.3A MAX	2 mm	70mΩ MAX	2C-3P	Non-shorting	200 ± 100gf	10,000 Cycle

Dimensions

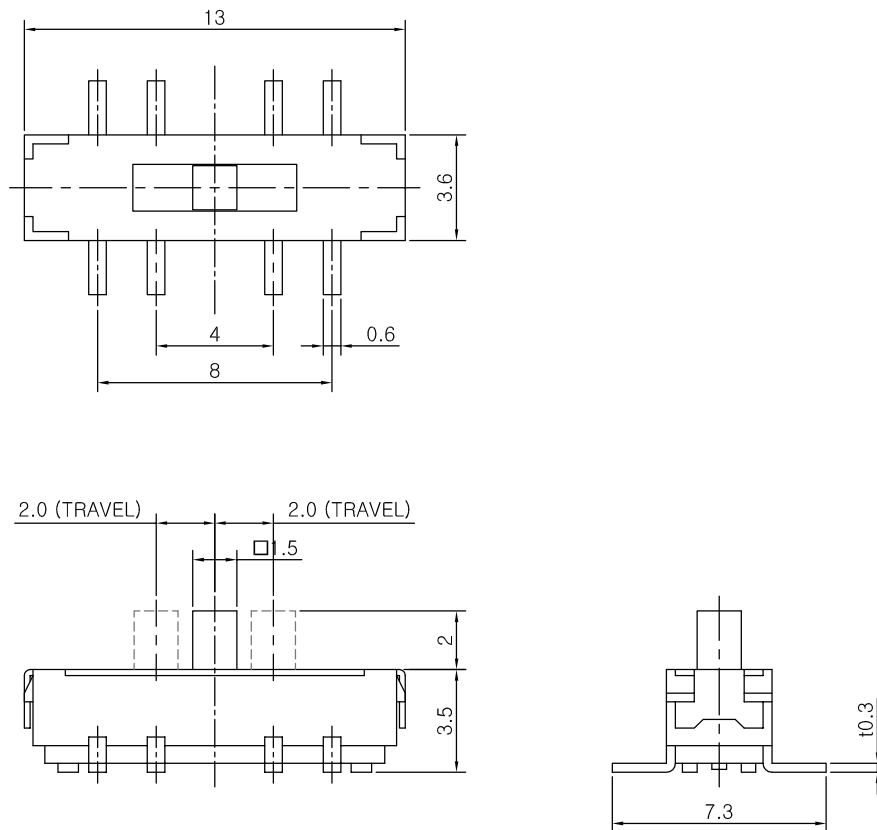

CIRCUIT DIAGRAM

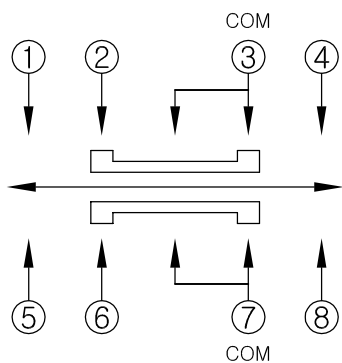

PCB MOUNTING HOLE DIMENSIONS

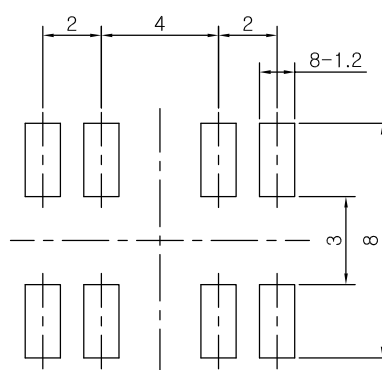

REEL POCKET

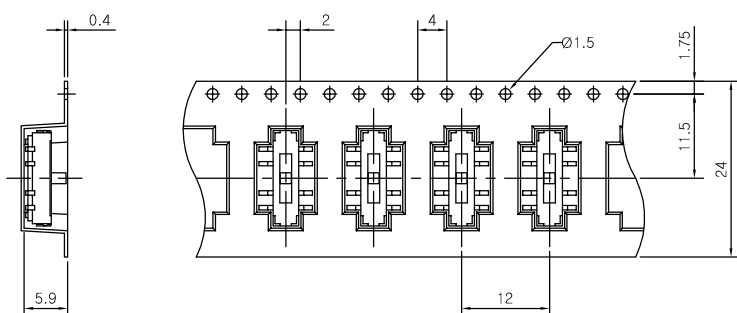

1. General Tolerance : 0.1mm
2. Angle for pocket side : 5°
3. Pocket Material : Plastic
4. Packing quantity : 1,000 PCS
5. Reel Diameter : 330mm