

Tact Switch

YST-1158P SMD Type

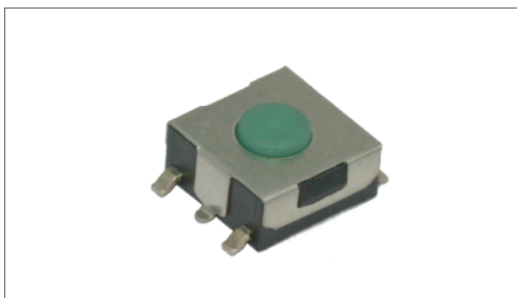

Feature

6.2mm x 6.5mm demenssion with anti-ESD ground.
Reflow solderable.

Available operating forces : 160gf, 250gf

Applications

Audio devices, office equipment, communication devices, TV set, video devices. etc.

Specifications

Item	Rating	Travel	Contact Registance	Bounce	Operating Force	Operating Life
Value	DC 12V 50mA MAX	0.25 ± 0.1mm	100mΩ MAX	10m sec MAX	160 ± 50gf	80,000 Cycle

Dimensions

Width (P)

	(Default)	by order			
Value (mm)	8.0	10.0			

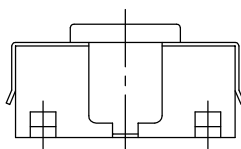
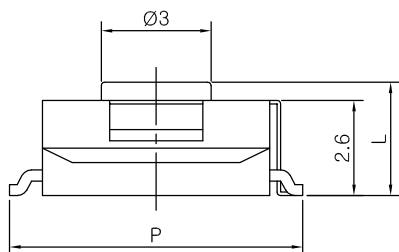
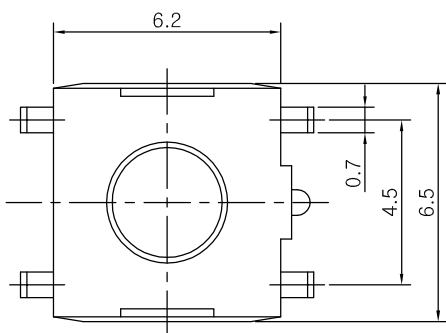

CIRCUIT DIAGRAM

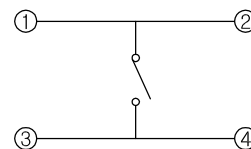

PCB MOUNTING HOLE DIMENSIONS

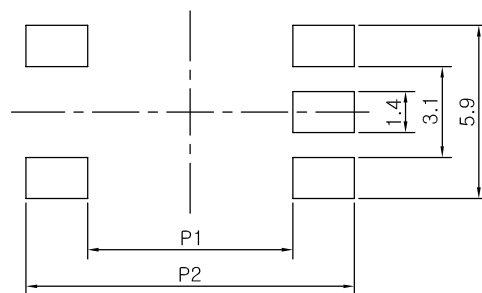

P (mm)	P1 (mm)	P2 (mm)
8.0	6.0	9.2
10.0	6.4	11.2

REEL POCKET

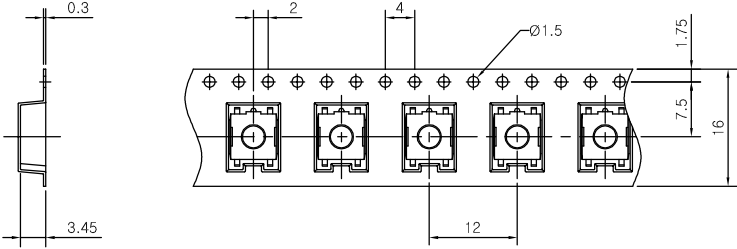

- 1. General Tolerance : 0.1mm
- 2. Angle for pocket side : 5°
- 3. Pocket Material : Plastic
- 4. Packing quantity : 1,500 PCS
- 5. Reel Diameter : 330mm