

Tact Switch

YST-1505B SMD Type

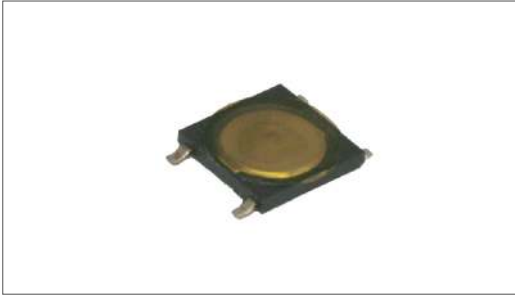

Feature

5mm x 5mm x 0.8mm outer dimension.
 Reflow solderable and dust prevented structure.

Available operating forces : 180gf, 250gf

Applications

For operating various electronic devices such as audio devices, communication devices, measuring instruments, etc.

Specifications

Item	Rating	Travel	Contact Resistance	Bounce	Operating Force	Operating Life
Value	DC 12V 50mA MAX	0.25 ± 0.1mm	100mΩ MAX	10m sec MAX	180 ± 50gf	200,000 Cycle

Dimensions

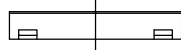
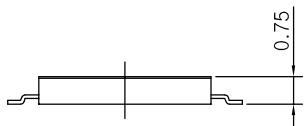
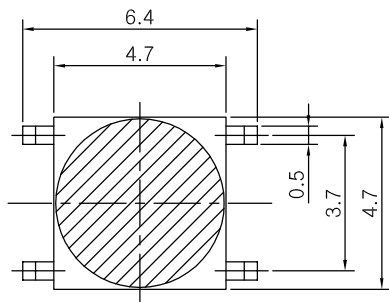

CIRCUIT DIAGRAM

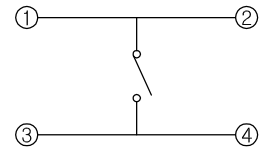

PCB MOUNTING HOLE DIMENSIONS

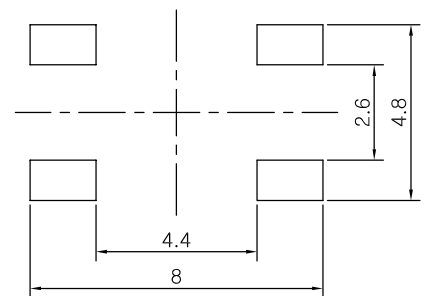

REEL POCKET

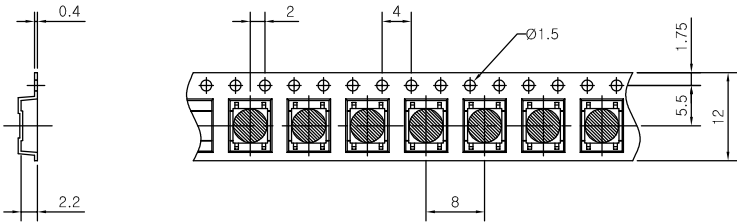

- 1. General Tolerance : 0.1mm
- 2. Angle for pocket side : 5°
- 3. Pocket Material : Plastic
- 4. Packing quantity : 4,000 PCS
- 5. Reel Diameter : 330mm