

Tact Switch

YST-1509 SMD Type

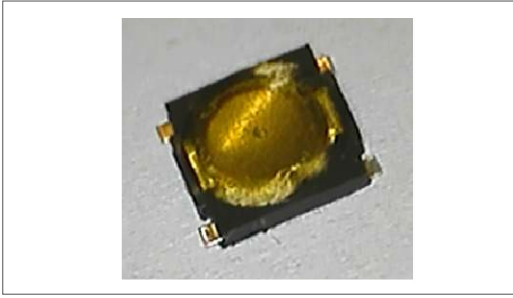

Feature

4.5x4.5x0.55mm outside dimensions for suitable high-density mounting.
Compact and reliable dust prevent structure.

Available operating forces : 180gf, 250gf

Applications

For operating various compact electronics devices like; mobile-phone, communication device, requiring high density mounting.

Specifications

Item	Rating	Travel	Contact Resistance	Bounce	Operating Force	Operating Life
Value	DC 12V 50mA MAX	0.2 ± 0.1mm	100mΩ MAX	10m sec MAX	180 ± 50gf	200,000 Cycle

Dimensions

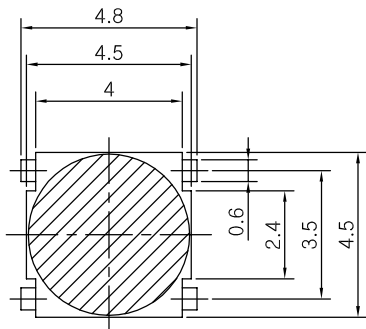

CIRCUIT DIAGRAM

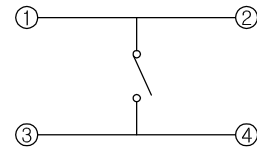

PCB MOUNTING HOLE DIMENSIONS

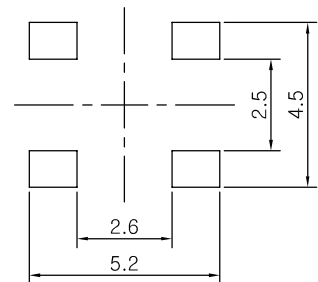

REEL POCKET

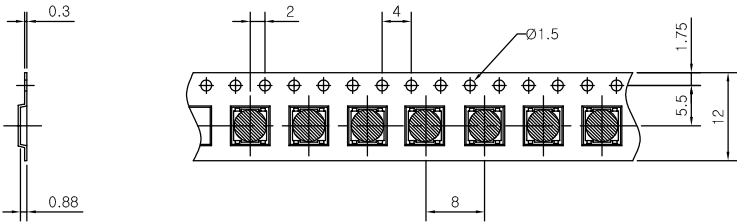

- 1. General Tolerance : 0.1mm
- 2. Angle for pocket side : 5°
- 3. Pocket Material : Plastic
- 4. Packing quantity : 7,000 PCS
- 5. Reel Diameter : 330mm